

# The new 905 model

Powell Sonaré Flutes

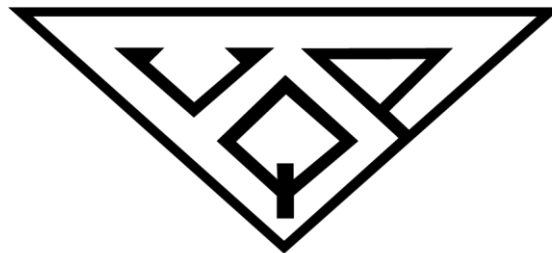

POWELL FLUTES  
B O S T O N

# Sonaré Flute trademark features

- Powell Modern Scale
  - Based on the Cooper Scale
  - Same Scale as all our Handmade Powell Professional flutes
- Powell patented Tone Hole Extrusion
  - Specialized tooling and technology designed to reduce production flaws and delays
  - Tone holes are spun up, rather than forced by ball bearing= less stress on the tubing
  - Finished with a diamond faced tool to ensure level pad seating
- Powell Hand-cut Signature Headjoint
  - Designed to resemble Powell Custom headjoints in character and sound
  - Hand-cut by the same makers who make Powell Custom headjoints
  - Can be kept and used when players want to upgrade to a full silver body Signature
- Powell Testing and Quality Control

# Placement within Powell Range

**Sonaré Family**



**Signature Family**



**Conservatory Family**

Silver



Aurumite 9K



**Custom Family**

Silver, Aurumite



9K, 10K, 14K,



18, 19.5K,

Platinum, Wood



# Powell Sonaré Flutes

Sterling Silver  
Signature Headjoint



**501 Model Y-Arms**  
Nickel Silver, Silver Plated Body  
Nickel Silver, Silver Plated Keys

Sterling Silver  
Signature Headjoint



**505 Model Pointed Arms**  
Nickel Silver, Silver Plated Body  
Nickel Silver, Silver Plated Keys

Sterling Silver  
Signature Headjoint



**601 Model Y-Arms**  
Sterling Silver Body  
Nickel Silver, Silver Plated Keys

Sterling Silver  
Signature Headjoint



**705 Model Pointed Arms**  
Sterling Silver Body  
Nickel Silver, Silver Plated Keys

# Headjoint Options

501   505   601   705

Standard Sterling Silver  
Signature Headjoint



K Style (Aurumite 9K Lip)  
Signature Headjoint



KT Style (Aurumite 9K  
Lip + Tube) Signature Headjoint



# Aurumite Process

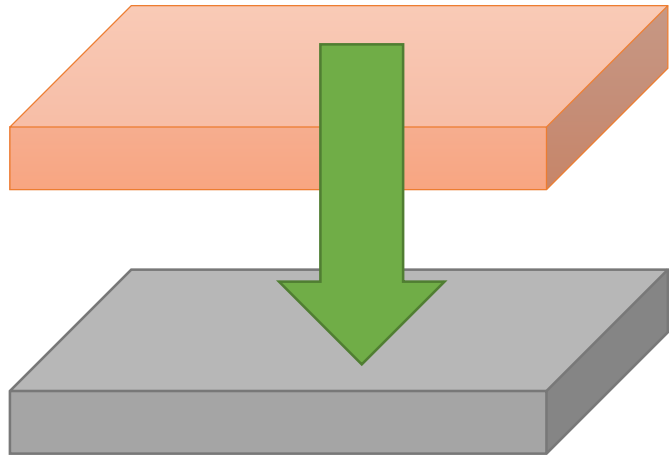

Gold layer is metallurgically bonded to Silver layer

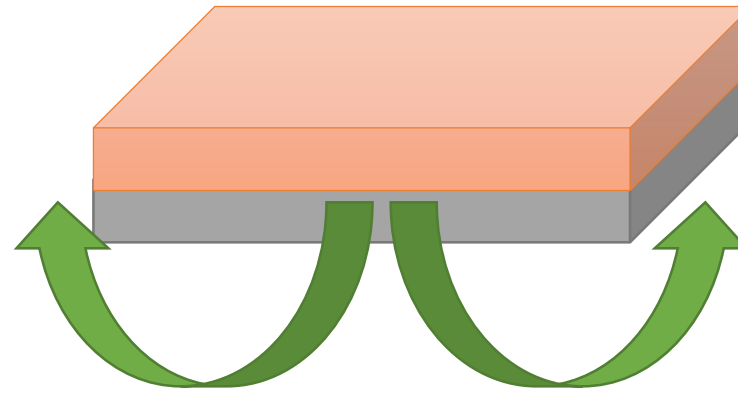

The fused layers are "cupped", forced upward into a cup shape

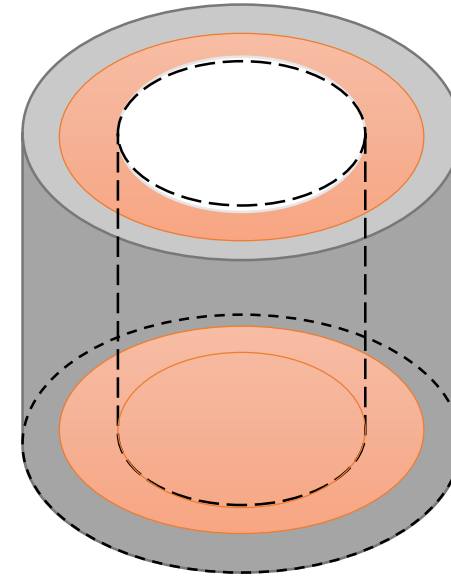

The cup is then drawn to size and length, forming tubing

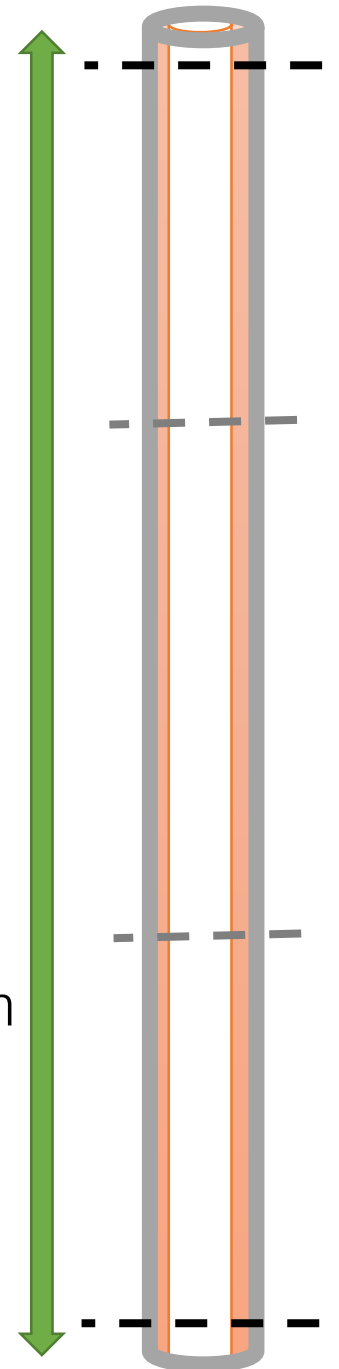

# The new 905

The first Sonaré model  
to offer a hand-  
finished **professional**  
**quality mechanism.**



# 905 Specifications



Pitch: A-442

## Body:

- Tubing Material: Sterling Silver
- **Barrel Material: Aurumite 9K**
- Tubing Thickness: .016 " / 0,406mm
- Tone hole Type: Drawn only
- Footjoint: B or C Foot available
- Gizmo: Standard
- Scale: Modern Powell Scale

## Headjoint:

- Tube Material: Sterling Silver
- **Lip Plate Material: Aurumite 9K**
- Wall Material: Sterling Silver
- **Crown Material: Aurumite 9K**

## Mechanism:

- Type: Traditional Pinned Mechanism with adjustment screws
- Keywork Material: Nickel Silver, Silver Plated
- G keys: In-line or Offset
- Cups: French or American
- Pointed Arms
- C# Trill available
- Split-E: Available
- Springs: 10K White Gold

## Pads:

- **Type: Straubinger Phoenix**

## case

- Hard case and **leather case cover**

## Options:

- KT Style headjoint



# What is hand-finishing?

- Completed by the same flute makers who make our professional handmade flutes, the following operations are done completely in the Powell Workshop
  - Checking and Fitting of Mechanics, steels, and pins
  - Installation of Springs and fitting of spring tension
  - Installation of Straubinger Phoenix Pads
  - Installation and custom shaping of trill corks, D# cork
  - Making, fitting, and adjusting of all felts/kickers
  - Adjustment and shimming of pads for final seal



# Straubinger Phoenix Pads

- When David Straubinger's shop burned in November, 2008, one set of his newly patented pads survived unscathed, the first set of pads made for the Avanti Flute (Avanti flutes are discontinued, the pads are still in production). Seemingly to rise out of the ashes of his shop, the pads were immediately named the Straubinger *Phoenix Pad* after the mythical bird that rises from its smoldering ashes to be reborn.
- The *Straubinger Phoenix Flute Pad's* outer felt covering, wraps around the outer rim of the pad instead of stopping at the pad edge. This, plus other special design features allows a sure seal, yet the pad produces a similar superior response, longevity with regards to adjustments, and the freedom of musical expression afforded by the traditional Straubinger Pad.



The Straubinger™ Flute Pad Assembly

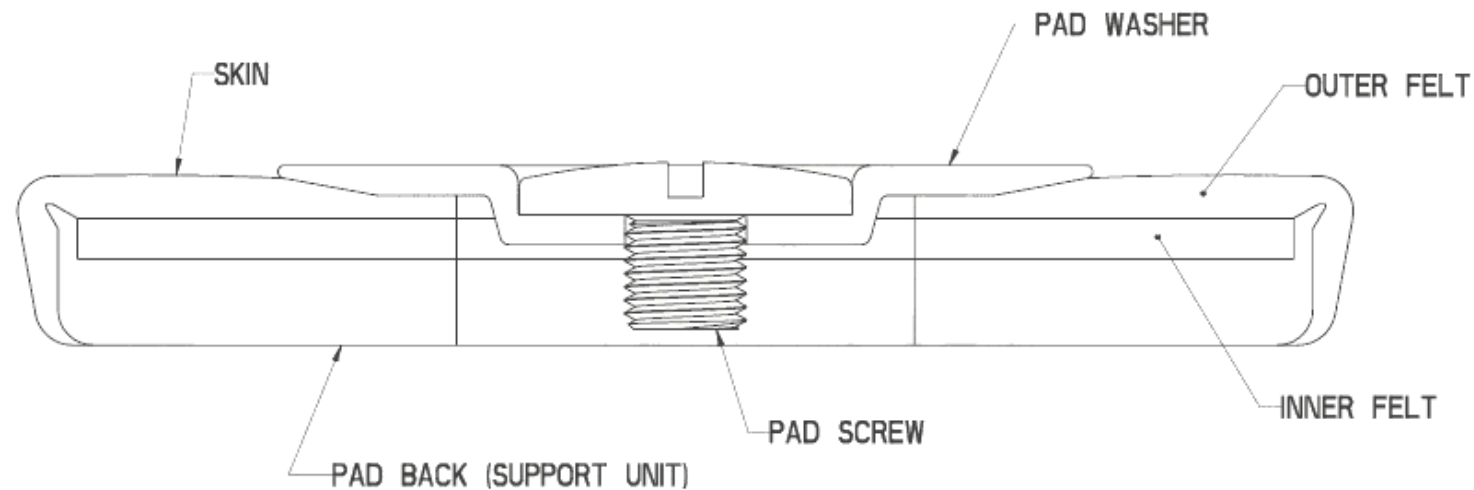

# Key References

- PS95BGF\_40615-2-0,
  - B foot, in-line G, Retail **€3800 ex. VAT**
- PS95BEF\_40615-2-0,
  - B foot, offset G, Split-E, Retail **€3800 ex. VAT**



# All References and Pricing

AX Ref	Item Name	Footjoint	Headjoint	Specs	List Price ex. VAT
PS95BGF_40615-2-0	POWELL SONARÉ 905 BGF/SIG-PS HJ .016 AG, A9 LIP, A9 CRWN, SII	B Foot	K Style	In-line	€ 3,800
PS95BOF_40615-2-0	POWELL SONARÉ 905 BOF/SIG-PS HJ .016 AG, A9 LIP, A9 CRWN, SII	B Foot	K Style	Offset	€ 3,800
PS95BEF_40615-2-0	POWELL SONARÉ 905 BEF/SIG-PS HJ .016 AG, A9 LIP, A9 CRWN, SII	B Foot	K Style	Offset Split-E	€ 3,800
PS95BOF#_40615-2-0	POWELL SONARÉ 905 BOF C#/SIG-PS HJ .016 AG, A9 LIP, A9 CRWN, SII	B Foot	K Style	Offset C# trill	€ 4,000
PS95CGF_40615-2-0	POWELL SONARÉ 905 CGF/SIG-PS HJ .016 AG, A9 LIP, A9 CRWN, SII	C Foot	K Style	In-line	€ 3,700
PS95COF_40615-2-0	POWELL SONARÉ 905 COF/SIG-PS HJ .016 AG, A9 LIP, A9 CRWN, SII	C Foot	K Style	Offset	€ 3,700
PS95CEF_40615-2-0	POWELL SONARÉ 905 CEF/SIG-PS HJ .016 AG, A9 LIP, A9 CRWN, SII	C Foot	K Style	Offset Split-E	€ 3,700
PS95BGF_40616-2-0	POWELL SONARÉ 905 BGF/SIG-PS HJ A9, A9 LIP, A9 CRWN, SII	B Foot	KT Style	In-line	€ 4,446
PS95BOF_40616-2-0	POWELL SONARÉ 905 BOF/SIG-PS HJ A9, A9 LIP, A9 CRWN, SII	B Foot	KT Style	Offset	€ 4,446
PS95BEF_40616-2-0	POWELL SONARÉ 905 BEF/SIG-PS HJ A9, A9 LIP, A9 CRWN, SII	B Foot	KT Style	Offset Split-E	€ 4,446
PS95BOF#_40616-2-0	POWELL SONARÉ 905 BOF C#/SIG-PS HJ A9, A9 LIP, A9 CRWN, SII	B Foot	KT Style	Offset C# trill	€ 4,646
PS95CGF_40616-2-0	POWELL SONARÉ 905 CGF/SIG-PS HJ A9, A9 LIP, A9 CRWN, SII	C Foot	KT Style	In-line	€ 4,346
PS95COF_40616-2-0	POWELL SONARÉ 905 COF/SIG-PS HJ A9, A9 LIP, A9 CRWN, SII	C Foot	KT Style	Offset	€ 4,346
PS95CEF_40616-2-0	POWELL SONARÉ 905 CEF/SIG-PS HJ A9, A9 LIP, A9 CRWN, SII	C Foot	KT Style	Offset Split-E	€ 4,346

# Questions?

Product specific questions can be sent to Flute Product Manager Daniel Sharp at [Daniel.Sharp@BuffetCrampon.com](mailto:Daniel.Sharp@BuffetCrampon.com).

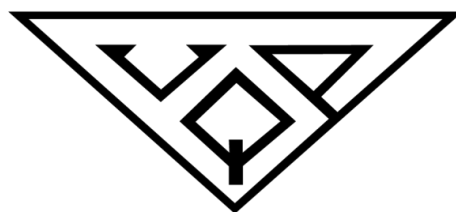

POWELL FLUTES  
B O S T O N